

<b>7310031</b>	ÖBB	Rh 2062	=	🔊	
<b>7320031</b>			=	🔊	~

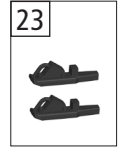

Pos. Nr. Pos.no.	Beschreibung Description	Art.-Nr. Art.no.	Preisgruppe Price bracket
1	Gehäuse kpl. Betr. nr. 2062 007-6 Body ass. complete Loco. no. 2062 007-6	150178	34
2	Platine mit Decoder PCB with decoder	150171	42
3	Flexleiter Flexible light conductor	145075	11
4	Spule Spool	143766	13
5	Lautsprecher Loudspeaker	129524	13
6	TS - Scheinwerfer Part set - Headlight	147773	11
7	Kessel + Kasten Boiler + boxes	150173	8
8	Lichtleiter abdeckung Light conductor cover	150179	4
9	TS - Fenster + Lichtleiter Part set - Windows + light conductor	150176	11
10	TS - Auftritte Part set - Steps	145089	7
11	TS - Geber, Ablassrohr, Part set - Encoder, drain pipe,	145090	7
12	TS - Griffe Part set - Handles	145091	8
13	Dose Socket	150177	3
14	Griff Umlauf Handle for running board	146259	4
15	Auspuff+Kühlergrill Chimney+grill	150180	12
16	Auspuffrohr Chimney pipe	150181	5
17	Antenne Antenna	137360	7
18	Türgriff Handrail	145102	6
19	GF-Schraube M1 6x4 mm GF-Screw	114850	3
20	Lampenring Lamp ring	146393	5
21	Scheibenwischer li+re Wipers L+R	145207	6
22	Hemmschuhe Rahmen Brake shoes frame	150174	4
23	Hemmschuhe Brake shoes	150175	5
24	TS-Gehäuse Part set-Body	150183	6
25	Eck-Griff Corner handle	150184	5

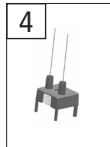

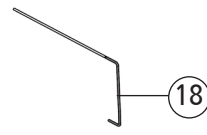
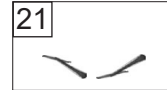
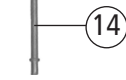
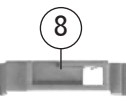
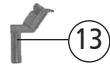
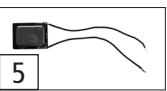
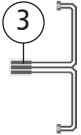
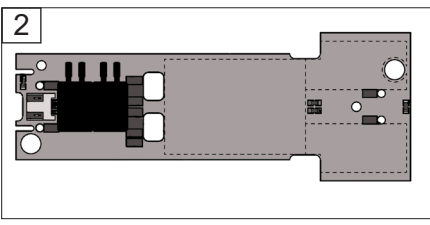
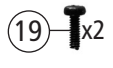
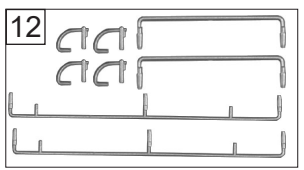
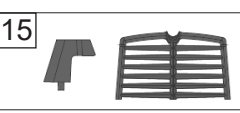
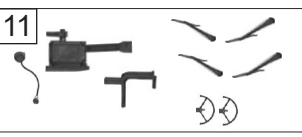
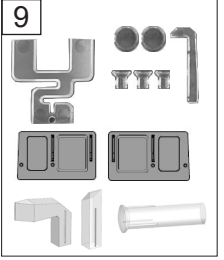
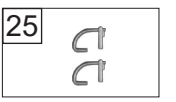
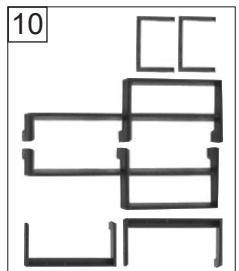
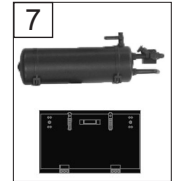
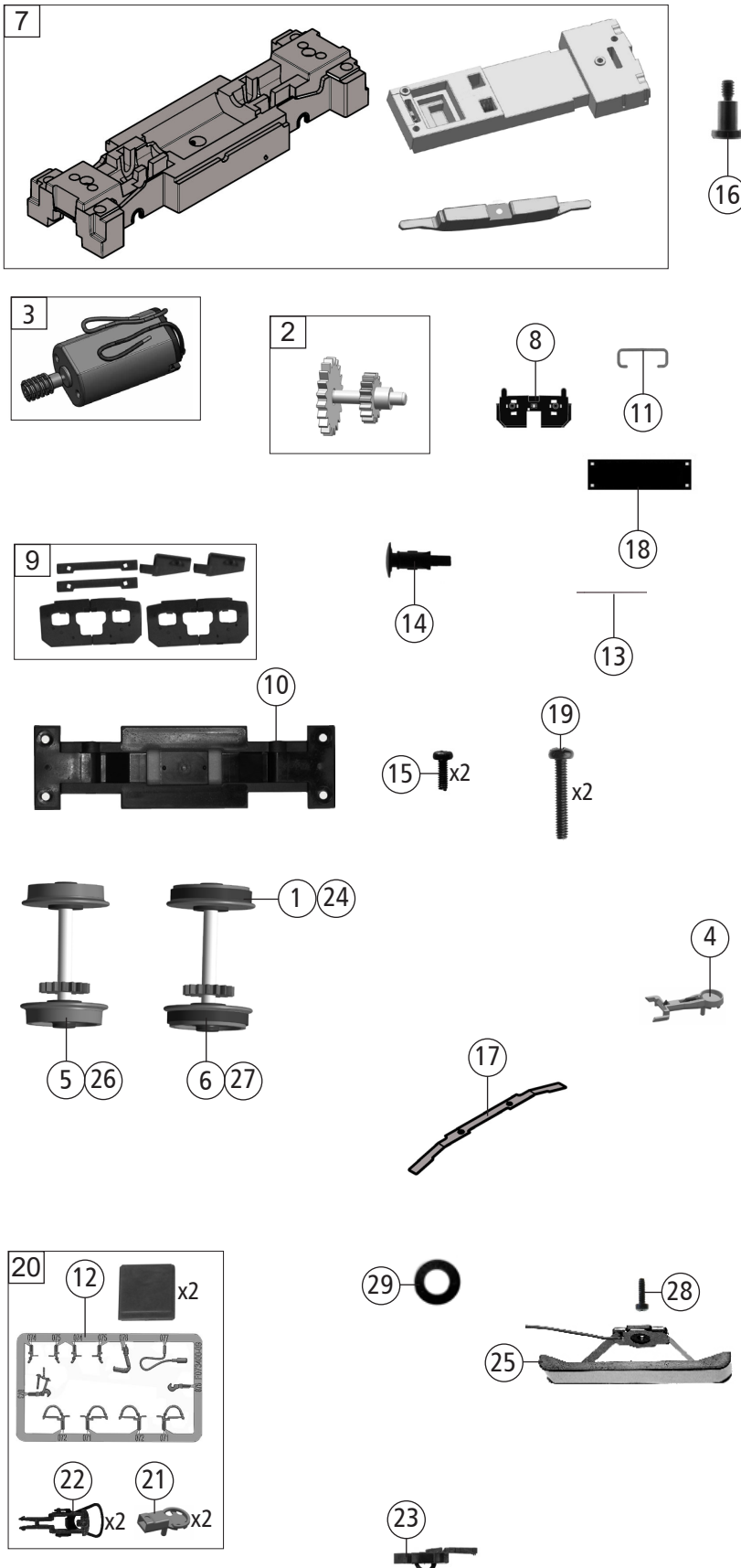

Pos. Nr. Pos.no.	Beschreibung Description	Art.-Nr. Art.no.	Preisgruppe Price bracket
7310031	ÖBB Rh 2062		
7320031			
1	Haftrings 10 stk. 10,3-12,8 Traction tyre 10 pcs.	40069	---
2	Getriebe kpl. Gearbox complete	145076	9
3	Motor Motor	145077	18
4	Digi-Kupplung Digital coupling	145078	11
5	Radsatz m.Zahnr. o.Haftr. Wheelset w. gearwh. w/o traction tyre	145079	11
6	Radsatz m.Zahnr. m. 2 Haftr. Wheelset w. gearwh. w. 2 traction tyres	145080	12
7	TS - Grundrahmen Part set - Base frame	145081	17
8	Rahmen l+b Frames	150172	13
9	TS - Ballast, Kontakhalter Part set - Weight, contact holder	145083	10
10	Boden Bottom	145088	4
11	Puffergriff Buffer handle	145092	4
12	TS - Bremsschläuche + Zughaken Part set of brake tubes & coupling hooks	139832	7
13	Federdraht L=18 D=0,25 mm Spring wire	145095	4
14	Puffer rund gewölbt Buffer round vaulted	88503	5
15	GF-Schraube M 2x12 mm GF-Screw	114944	3
16	Ansatzschraube M2x4 mm Flanged screw	108167	4
17	Radkontakt L=55,6 mm Contact	145097	8
18	Nummerntafel Number plates	150182	8
19	Schraube M 2x20 mm Screw	108926	3
20	Zurüstbeutel Bag of accessories	150185	11
21	Kupplungskammer Coupling housing	143790	4
22	Standardkupplung kpl. Standard coupling assembly	89246	6
23	Kurzkupplung Short coupling	115550	6
<b>AC - Wechselstrom</b>			
24	Haftrings 10 stk. 10,3-12,4 Traction tyre 10 pcs.	40074	---
25	Schleifer kurz Slider short	40064	---
26	Radsatz m.Zahnr. o.Haftr. AC Wheelset w. gearwh. w/o traction tyre	145105	11
27	Radsatz m.Zahnr. m. 2 Haftr. AC Wheelset w. gearwh. w. 2 traction tyres	145106	12
28	PT-Schraube M1 5x5 mm PT-Screw	108137	3
29	Beilagescheibe Washer	86108	3